

Mitos Dropix® Droplet Generation System



product datasheet	page
Description	3
Mitos Dropix® Droplet Generation system	4
Benefits	5
System specifications	5
Applications	5
Modes of operation	6
Mitos Dropix®	8
Mitos Dropix® accessories	9
Mitos Dropix® system accessories	13
Droplet Formation	16
IP License	17



Part No.	Part Description	#
3200350	Mitos Dropix®	1
3200197	USB to RS232 Adaptor Cable	1
3200349	Droplet Storage Coil – 0.25mm	1
3200414	Dropix® Fluid Reservoir - PMMA	1
3200354	Dropix® Fluid Reservoir - PEEK	1
3200351	Dropix® Sample Strip (Pack of 8)	1
3200356	Dropix® Sample Strip Holder	1
3200353	Dropix® Sample Hook – 0.8mm	1
3200355	Dropix® Sample Hook Fitting – 0.8mm	1
3200302	FEP Tubing, 0.8mm x 0.25mm, 10 metres	1
3200306	Flangeless Ferrule 0.8mm, ETFE (pack of 10)	1
3200307	End Fittings and Ferrules for 0.8mm Tubing (pack of 10)	1
3200057	Mitos Duo XS-Pump	1
3000252	Syringe for Mitos Duo XS-Pump, 1ml	2
3000245	Valve for Mitos Duo XS-Pump (3 Port)	2
3200050	High Speed Camera and Microscope System	1

Description

Mitos Dropix® is a novel droplet-on-demand system designed for easy generation of extremely miniaturized droplet compartments with excellent control over volume, environment and isolation of contents. This compact off-chip droplet generator enables users to create combinatorial droplet arrays of many different reagents for complex assays.

Using droplet “picking” technology, the Mitos Dropix® (Part No. 3200350) features a Dropix® Sample Hook - 0.8mm (Part No. 3200353) moving up and down between the Dropix® Fluid Reservoir (available in PEEK Part No. 3200354 or PMMA Part No. 3200414 version) containing the carrier phase and a Dropix® Sample Strip (Pack of 8) (Part No. 3200351) with aqueous solutions in 24 bottomless wells for droplet generation. It also moves side to side along the Dropix® Sample Strip for reagent selection.

Accessories for Mitos Dropix® include the Dropix® Sample Strip Holder (Part No. 3200356), a SBS 192 well plate configuration which allows integration with existing standard fluid handling systems. Up to 8 Dropix® Sample Strips can be inserted in the Dropix® Sample Strip Holder, facilitating preparation prior to operating with the Mitos Dropix®.

Mitos Dropix® allows the user to pre-program commands for droplet collection via an easy-to-use PC software user interface. This allows long droplet collection sequences to be run autonomously with a short set-up time and also means that the user defined settings can be saved so that they can be used on multiple occasions, which saves time when repeating experiments.

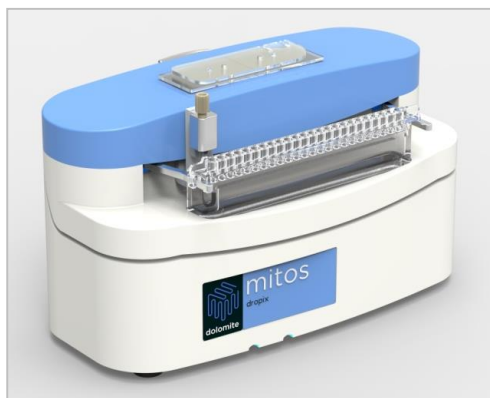

Left: Mitos Dropix for droplet-on-demand applications with reagents **Right: Dropix Sample Strip (Pack of 8) (Part No. 3200351)**

Mitos Dropix® Droplet Generation system

A typical system set up includes the Mitos Dropix® (Part No. 3200350) connected to a PC via a USB cable for control of droplet size and frequency via the Dropix® software on a PC. A Mitos Duo XS-Pump (Part No. 3200057) with two 1ml syringes and two 3-port valves is required for pumping aspiration and can also be used for waste disposal collection. The XS pump, due to its dual syringe function, has the added benefit of constantly refilling the carrier fluid bath during operation, thereby maintaining a steady fluid level. Moreover, a single XS-Pump can operate 2 x Mitos Dropix® systems independently.

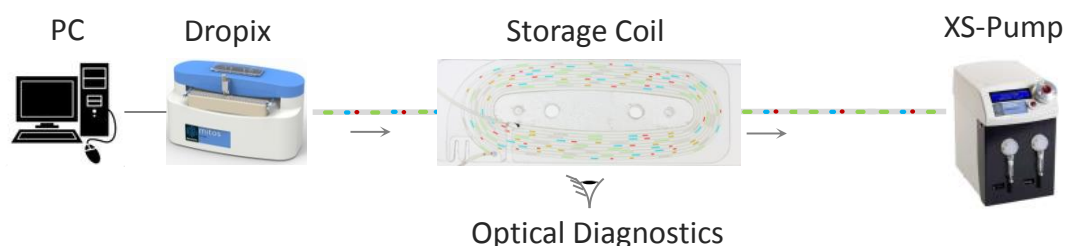

Fluidic connections between the Mitos Dropix®, Droplet Storage Coil (Part No. 3200349), the Dropix® Sample Hook (Part No. 3200353) and Dropix® Sample Hook Fitting (Part No. 3200355) and the Mitos Duo XS-Pump are made using FEP tubing of OD 0.8 mm and ID 0.25 mm (Part No. 3200302). Flangeless Ferrule 0.8mm, ETFE (Part No. 3200306) and End Fittings and Ferrules for 0.8mm Tubing (Part No. 3200307) are useful for making connections with the pump. Visualization can be achieved using a DSLR camera with a macro-lens and brightfield imaging, or other optical imaging system, such as the High Speed Camera and Microscope System (Part No. 3200050).

This is a suggested mode of operation, but the use of Mitos Dropix® can be customized to suit specific requirements, such as using with a droplet chip or a merging chip, or having multiple Mitos Dropix® units for scaling-up production.

Benefits

- Small portable device
- Easy to set up with no tools required
- Automated production of droplets from 24 samples in any sequence
- Ability to generate droplet sizes down to 50nl
- Ability to generate up to 5 droplets per second
- Full visibility of the samples and droplet generation within the Dropix® Fluid Reservoir - PMMA (Part No. 3200414)
- Storage of droplets in the removable transparent Droplet Storage Coil - 0.25mm (Part No.3200349) for external experimentation and analysis
- Can run autonomously for up to 24 hours after setup
- Excellent control of droplet size and frequency via PC software

System Specifications

Specification	
Droplet size range	50nl+
Droplet flow rates	0.7-15ul/min
Droplet frequency	Up to 5 per second
Wetted materials	FEP, Stainless Steel, COC
Weight and size	20x12x8cm, 1.5kg
Current	1.5 Amps
Voltage	24V DC

Applications

Mitos Dropix® benefits a wide range of industries including pharmaceutical, food, agrochemical, cosmetics and research and can be used for the following applications:

- Droplet library creation
- Cell encapsulation
- Diagnosis screening
- Synthetic chemistry
- Drug bioassays

Modes of operation

The Mitos Dropix® system can operate in four different configurations from nanoliter to picoliter range and from 24 reagents benefiting multiple applications. These may be further customized to suit specific requirements.

Mode of operation	Range	No of Reagents	Applications
Mode 1	Nanoliter	Up to 24	Droplet library Cell encapsulation
Mode 2	Nanoliter	Up to 24	Diagnosis screening Synthetic chemistry Drug discovery Particle production Hydrogel particle production Protein crystallization Bioassays
Mode 3	Picoliter	Up to 24	Diagnosis screening Synthetic chemistry Drug discovery Particle production Hydrogel particle production Protein crystallization Bioassays
Mode 4	Nanoliter/picoliter	> 24	Diagnosis screening Synthetic chemistry Drug discovery Particle production Hydrogel particle production Protein crystallization Bioassays

Mode 1: Simple droplet sequence with variable type and size

This mode creates a sequence reference droplet library. The portable Droplet Storage Coil - 0.25mm (Part No. 3200349) can be removed for further examination of the droplets. A single Mitos Dropix® has the capacity to store 24 different fluids, and therefore the library consists of 24 different compositions.

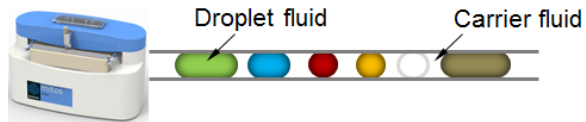

Mode 2: Mixing or concentration gradients from 2 or more wells using a merging chip

This mode features a Dropix® Merger Chip for merging to create concentration gradients from 2 or more wells, resulting in effectively infinite droplet combinatorial reactions.

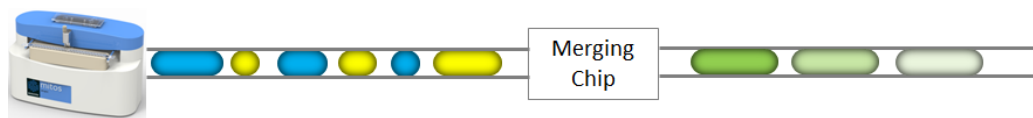

Mode 3: From nanoliter to picoliter technology

This mode features a droplet chip. Either in-line with mode 2, or independently, mode 3 extends Mitos Dropix® from nanoliter technology to picoliter technology.

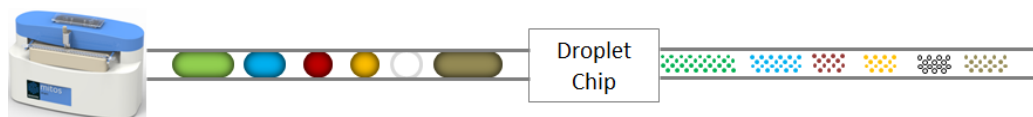

Mode 4: Synchronized multiple Mitos Dropix®

For applications requiring more than 24 starting solutions, multiple Mitos Dropix® will be required.

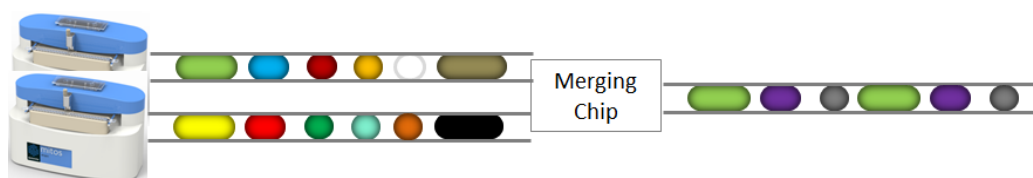

Mitos Dropix® (Part No. 3200350)

Mitos Dropix® (Part No. 3200350) features a portable device for droplet sequence production and sampling, enabling users to have defined arrangement of precise volume droplets from up to 24 unique sources.

Accessories such as the Dropix® Fluid Reservoir - PEEK (Part No. 3200354), Dropix® Fluid Reservoir - PMMA (Part No. 3200414), Dropix® Sample Strip (Part No. 3200351), Dropix® Sample Hook - 0.8mm (Part No. 3200353), Dropix® Sample Hook Fitting 0.8mm (Part No. 3200355) and Droplet Storage Coil - 0.25mm (Part No. 3200349) are mounted within this main unit.

Benefiting from a very precise electro-mechanical design, the Mitos Dropix® is controlled by a PC for droplet size and frequency, run autonomously with small amounts of set-up time and also can be saved to be used on multiple occasions.

Benefits

- Compact and portable device
- Time - efficient and flexible solution allowing users to combine multiple reagents to create complex assays
- Generates droplets of up to 24 different samples
- Stores up to 1000 droplets with sizes down to 50nl
- Full visibility of the droplets

Geometry:

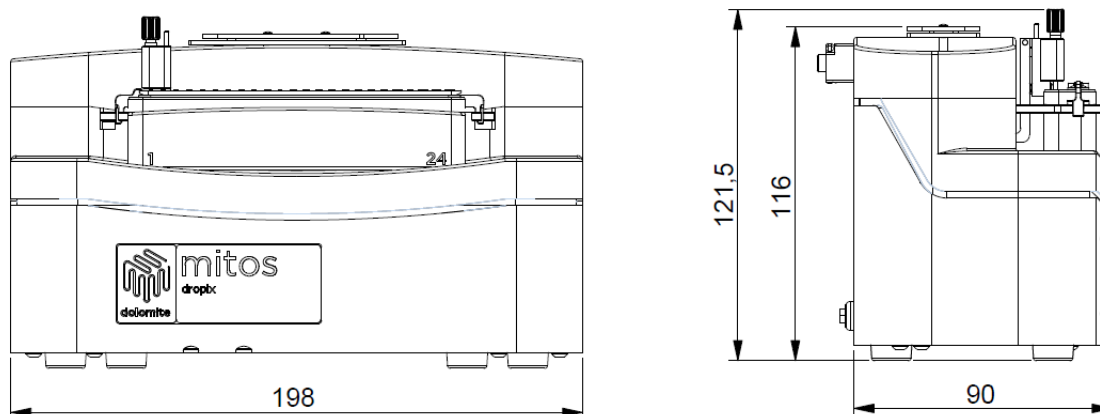

Droplet Storage Coil - 0.25mm (Part No. 3200349)



The Droplet Storage Coil - 0.25mm (Part No. 3200349) comes in a pack of three portable holders containing 1 meter of natural FEP tube (0.8mm OD, 0.25mmID) pre-coiled within.

Made of PMMA acrylic, this holder is placed on the top of the Mitos Dropix®, facilitating the produced droplets to flow up the tube and allowing easy visualization of the droplets.

Additionally, these coils provide the ability to seal off the tube so that they can be removed as a sealed storage unit and be used for further experimentation.

**Droplet Storage Coil - 0.25mm
(Part No. 3200349)**

Benefits

- Collects and stores sample droplets
- Allows droplets to be easily contained and removed for further experimentation
- Allows visualization of the droplets
- Reusable by removing tubing and winding on another length
- Easy slots onto the top of the Mitos Dropix®

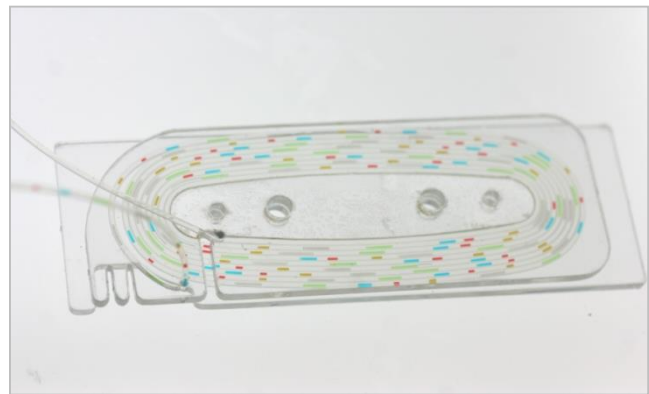
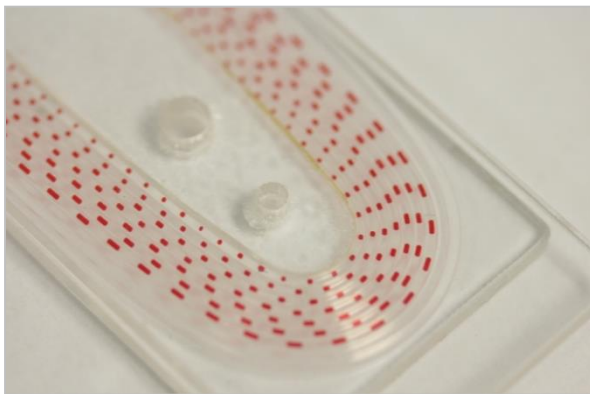

Visualisation of droplets generated from different reagents within the Droplet Storage Coil - 0.25mm

Dropix® Sample Strip (Pack of 8) (Part No. 3200351)



The Dropix® Sample Strip (Pack of 8) (Part No. 3200351) is a chemically robust strip of 24 wells each. Each Mitos Dropix® (Part No. 3200350) can hold one Dropix® Sample Strip containing the reagents for the droplet formation.

Made of COC, the strips can be used in a 192 well plate configuration with the Dropix® Sample Strip Holder (Part No. 3200356).

Dropix Sample Strip (Pack of 8) (Part No. 3200351)

Benefits:

- Easy to install and remove with no tools required
- High visibility of the reagents
- Allows configuration into a 192 industry standard well plate for automated sample loading with the Dropix® Sample Strip Holder (Part No. 3200356)
- Excellent chemical compatibility

Dropix® Sample Strip Holder (Part No. 3200356)



The Dropix® Sample Strip Holder (Part No. 3200356) provides a base to hold up to 8 Dropix® Sample Strips (each Dropix® Sample Strip contains 24 wells) forming an SBS 192 well plate.

This formation facilitates integration with existing handling systems and is useful for the filling of sample strips outside of the carrier vessel prior to using Mitos Dropix®. Very chemically resistant, it can also be used for holding and storing the sample strips after usage, without leakage.

Dropix Sample Strip Holder (Part No. 3200356)

Dropix® Fluid Reservoir - PEEK (Part No. 3200354)

The Dropix® Fluid Reservoir - PEEK (Part No. 3200354) provides constant carrier fluid (typically FC40 oil) to the Mitos Dropix®. With a maximum fill volume of 25ml, this fluid reservoir made of PEEK comes with a lid to prevent contamination and evaporative loss between usages. Highly chemically resistant.

The Dropix® Sample Hook - 0.8mm (Part No. 3200353) passes through the fluid in the reservoir whilst taking the tube in and out of the sample wells, providing a constant flow.

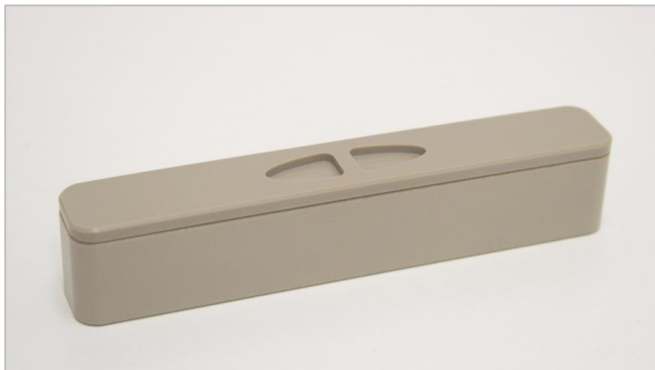

Dropix Fluid Reservoir - PEEK (Part No. 3200354)

Dropix® Fluid Reservoir - PMMA (Part No. 3200414)

The Dropix® Fluid Reservoir - PMMA (Part No. 3200414) provides constant carrier fluid (typically FC40 oil) to the Mitos Dropix® and allows maximum visibility of the droplet formation. With a maximum fill volume of 25ml, this fluid reservoir comes with a PEEK lid to prevent contamination and evaporative loss between usages.

The Dropix® Sample Hook - 0.8mm (Part No. 3200353) passes through the fluid in the reservoir whilst taking the tube in and out of the sample wells, providing a constant flow.

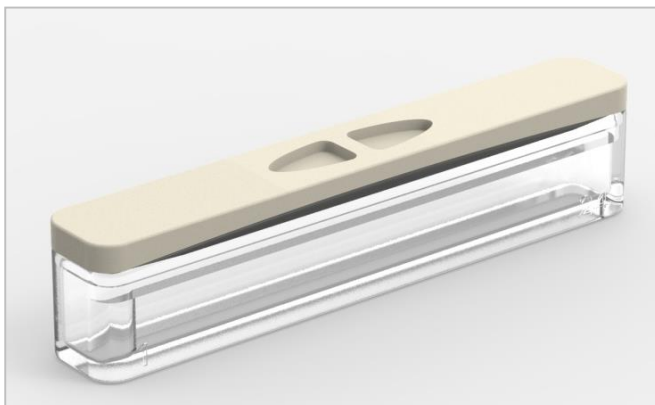

Dropix Fluid Reservoir - PMMA (Part No. 3200414)

Dropix® Sample Hook - 0.8mm (Part No. 3200353)



The Dropix® Sample Hook - 0.8mm (Part No. 3200353) guides the tubing down and around the Dropix® Sample Strip (Part No. 3200351) so the tubing is directed upwards underneath the wells. Made of stainless steel and very chemically resistant, the Dropix® Sample Hook - 0.8mm holds the tube securely during operation with a fixed bend radius.

The Dropix® Sample Hook - 0.8mm works together with the Dropix® Sample Hook Fitting - 0.8mm (Part No. 3200355).



Left: Dropix Sample Hook - 0.8mm with fitting guiding the tubing around the Dropix Sample Strip (Part No. 3200351)

Right: Dropix Sample Hook - 0.8mm (Part No. 3200353)

Benefits:

- Precisely holds the tube securely during operation
- Excellent chemical compatibility
- Compatible with FEP tube (0.8mm OD, 0.25mmID)

USB to RS232 Adaptor Cable (Part No. 3200197)



For PCs that do not have an RS232 serial interface, Dolomite offers an RS232 to USB Adaptor Module allowing users to connect their Mitos P-Pump Basic (Part No. 3200175) or Mitos P-Pump Remote Basic (Part No. 3200177) to a PC

USB to RS232 Adaptor Cable (Part No. 3200197)

Dropix® Sample Hook Fitting - 0.8mm (Part No. 3200355)



The Dropix® Sample Hook Fitting - 0.8mm (Part No. 3200355) is a small threaded fitting that screws into the top of the Dropix® Sample Hook - 0.8mm (Part No. 3200353) to clamp the tubing to the Droplet Storage Coil - 0.25mm (Part No. 3200349). Highly chemically resistant and made from stainless steel, PEEK and rubber O-ring, it works by clamping down onto an O-ring that holds the tubing in place inside the hook.

Dropix Sample Hook Fitting - 0.8mm (Part No. 3200355)

Benefits:

- Easily screws into the Dropix® Sample Hook - 0.8mm (Part No. 3200353) with no tools required
- Excellent chemical compatibility
- Compatible with FEP tube (0.8mm OD, 0.25mmID)

FEP Tubing, 0.8mm x 0.25mm, 10 metres (Part No. 3200302)

Fluid Tubes can be used to connect the Mitos Syringe Pumps (Part No. 3200057), to modules that have a 1/4 -28 thread using an end fitting and ferrule. The FEP tubes are translucent offering a better optical clarity and accuracy.



Features and Benefits:

- Quick and easy to set up and connect
- Excellent chemical resistance
- Max operating pressure: 150 bar
- Operating temperature range -51°C to 50 °C

FEP Tubing, 0.8mm x 0.25mm,
10 metres (Part No. 3200302)

Flangeless Ferrule 0.8mm, ETFE (pack of 10) (Part No. 3200306)



Flangeless Ferrule 0.8mm, ETFE (Part No. 3200306) and End Fittings and Ferrules for 0.8mm Tubing (Part No. 3200307) are useful for making connections with the Mitos Duo XS-Pump. Available in a pack of 10.

Flangeless Ferrule 0.8mm, ETFE (Part No. 3200306)

End Fittings and Ferrules for 0.8mm Tubing (pack of 10) (Part No. 3200307)



End Fittings and Ferrules for 0.8mm Tubing (Part No. 3200307) and Flangeless Ferrule 0.8mm, ETFE (Part No. 3200306) are used for making connections with the Mitos Duo XS-Pump. The pack contains 10 x Delrin end fittings with $\frac{1}{4}$ " - 28" thread, 10 x ETFE ferrules for 0.8mm ($\frac{1}{32}$ " OD) pipe and 1 x precision pipe cutter

End Fittings and Ferrules for 0.8mm Tubing (pack of 10) (Part No. 3200307)

Mitos Duo XS-Pump (Part No. 3200057)



The Mitos Duo XS-Pump has been specifically developed for applications such as droplet generation, where an extremely smooth flow rate is required. The microfluidic pumping system achieves this through its advanced drive electronics that eliminate the pulsation from the stepper motor, providing a pulse-free flow.

Mitos Duo XS-Pump (Part No. 3200057)

Features and Benefits:

- Versatile with many modes of operation
- Advanced drive electronics
- Easy to use
- Small footprint
- Extra smooth pump option to eliminate most pulsation issues
- Wide temperature/pressure range
- Wide flow rate range - syringes are easily replaceable
- Excellent chemical compatibility
- Software to control the pump from a PC is available on request

Syringe for MitoS Duo XS-Pump, 1ml (Part No. 3000252)



User replaceable syringe that allows a wide flow rate range. Can be used together with the MitoS Duo XS-Pump (Part No. 3200057).

Features and Benefits:

- 1ml Syringe
- Typical flow rates: 10 μ l/min to 2ml/min

Syringe for MitoS Duo XS-Pump, 1ml
(Part No. 3000252)

Valve for MitoS Duo XS-Pump (3 Port) (Part No. 3000245)



Can be used together with the MitoS Duo XS-Pump (Part No. 3200057).

Features and benefits:

- 3 Port Valve
- Max. pressure: 6bar

Valve for MitoS Duo XS-Pump (3
Port) (Part No. 3000245)

High Speed Camera and Microscope System (Part No. 3200050)



High Speed Camera and Microscope System (Part No. 3200050)

The High Speed Camera and Microscope System is a high quality and flexible solution for general microscopy and high speed image capture in microfluidic applications. It features an easy-to-use microscope with wide zoom range and long working distance. The microscope stage is designed to accommodate all types of microfluidic chips and enables users to quickly locate and observe the area of interest. The high speed camera integrates with the microscope and provides image capture at speeds of over 1000fps via FireWire link to a desktop PC. Illumination is provided by a 150W illuminator with alternative fibre optic light guides for different lighting options.

Features and benefits:

- Wide zoom range
- Long working distance
- Still image and high speed video capture
- View through microscope or live images on PC
- Ideal for observation of microfluidic experiments
- High power illumination from above or below
- Easy to use

Droplet Formation

The size, consistency, and production rate of droplet formation is a function of several physical parameters, including:

- Viscosity and surface tension of the various fluids
- Presence of surfactants
- Miscibility of the fluids
- Total flow rate and relative flow rate of each fluid
- Flow stability
- Channel size of microfluidic chip (if being used with MitoS Dropix®)

To accelerate development work in droplet microfluidics, Dolomite offers a range of modular micro droplet systems featuring Dolomite's industry leading microfluidic pumps, connectors and chips. We recommend using MitoS Dropix® with the MitoS Duo XS-Pump, which is a



syringe pump developed for applications such as droplet generation where an extremely smooth flow rate is required.

Please contact Dolomite to configure a droplet system that fits your requirements.

IP License

Mitos Dropix® was developed by Dolomite under exclusive sub-licence with Drop-Tech Ltd. having won Dolomite's 2012 Productizing Science® competition. Drop-Tech was formed from an academic collaboration between Cambridge University and Imperial College London and is the exclusive licensee of their patented droplet generation technology used in Mitos Dropix® (**Patent Pending: PCT/GB2013/051668**).